

GEOTHERMAL EQUIPMENT

ClimateMaster-Commercial

Tranquility 16



- Available in sizes 3/4 tons through 5 tons with multiple cabinet configurations
- Small cabinet size to fit into tight spaces
- Exceeds ASHRAE 90.1 efficiencies
- Extended range refrigerant circuit allows unit to be used in ground loop, ground water and water loop applications
- Standard features include microprocessor controls, galvanized/powder coated cabinet and TXV
- Horizontal units are left-right field convertible; vertical units are front-back field convertible
- Electrical box and air discharge are field convertible
- Made in the USA

HVAC No.	MFG Part No.	Tons A/C	Configuration	Voltage	Return	Supply	Price
387222	TCH009AEC10CLSS	3/4	Horizontal	265/60/1	Left	Straight	\$2,978.72
387223	TCH009AEC10CRSS	3/4	Horizontal	265/60/1	Right	Straight	\$2,978.72
387174	TCH009AGC10CLSS	3/4	Horizontal	208-230/60/1	Left	Straight	\$2,915.43
387175	TCH009AGC10CRSS	3/4	Horizontal	208-230/60/1	Right	Straight	\$2,965.79
387190	TCH012AGC10CLSS	1	Horizontal	208-230/60/1	Left	Straight	\$3,086.87
387191	TCH012AGC10CRSS	1	Horizontal	208-230/60/1	Right	Straight	\$3,086.87
379767	TCH015*GC10CLSS	1-1/4	Horizontal	208-230/60/1	Left	Straight	\$3,388.79
379769	TCH015*GC10CRSS	1-1/4	Horizontal	208-230/60/1	Right	Straight	\$3,388.79
392423	TCH015AEC10CLSS	1-1/4	Horizontal	265/1/60	Left	Straight	\$3,437.24
392424	TCH015AEC10CRSS	1-1/4	Horizontal	265/1/60	Right	Straight	\$3,437.24
391289	TCH018*EC10CLSS	1-1/2	Horizontal	265/60/1	Left	Straight	\$3,653.56
389805	TCH018*EC10CRSS	1-1/2	Horizontal	265/60/1	Right	Straight	\$3,653.56
379783	TCH018*GC10CLSS	1-1/2	Horizontal	208-230/60/1	Left	Straight	\$3,601.90
379785	TCH018AGC10CRSS	1-1/2	Horizontal	208-230/60/1	Right	Straight	\$3,601.90
379799	TCH024*GC10CLSS	2	Horizontal	208-230/60/1	Left	Straight	\$3,761.75
390075	TCH024AEC10CLSS	2	Horizontal	265/60/1	Left	Straight	\$3,805.33
390074	TCH024AEC10CRSS	2	Horizontal	265/60/1	Right	Straight	\$3,805.33
379801	TCH024AGC10CRSS	2	Horizontal	208-230/60/1	Right	Straight	\$3,761.75
379815	TCH030*GC10CLSS	2-1/2	Horizontal	208-230/60/1	Left	Straight	\$4,081.41
379817	TCH030*GC10CRSS	2-1/2	Horizontal	208-230/60/1	Right	Straight	\$4,081.41
391913	TCH030AEC10CLSS	2-1/2	Horizontal	265/60/1	Left	Straight	\$4,134.69
391912	TCH030AEC10CRSS	2-1/2	Horizontal	265/60/1	Right	Straight	\$4,134.69
379863	TCH036*GC10CLSS	3	Horizontal	208-230/60/1	Left	Straight	\$4,238.01
379865	TCH036*GC10CRSS	3	Horizontal	208-230/60/1	Right	Straight	\$4,238.01
379895	TCH036*HC10CLSS	3	Horizontal	208-230/60/3	Left	Straight	\$4,328.42
379897	TCH036*HC10CRSS	3	Horizontal	208-230/60/3	Right	Straight	\$4,328.42
379879	TCH036AFC10CLSS	3	Horizontal	460/60/3	Left	Straight	\$4,394.61
379881	TCH036AFC10CRSS	3	Horizontal	460/60/3	Right	Straight	\$4,394.61
379927	TCH042AFC10CLSS	3-1/2	Horizontal	460/60/3	Left	Straight	\$4,680.38
379929	TCH042AFC10CRSS	3-1/2	Horizontal	460/60/3	Right	Straight	\$4,680.38
379991	TCH048*HC10CLSS	4	Horizontal	208-230/60/3	Left	Straight	\$5,027.48
379993	TCH048*HC10CRSS	4	Horizontal	208-230/60/3	Right	Straight	\$5,027.48
379975	TCH048AFC10CLSS	4	Horizontal	460/60/3	Left	Straight	\$5,106.59
379977	TCH048AFC10CRSS	4	Horizontal	460/60/3	Right	Straight	\$5,109.05
379959	TCH048AGC10CLSS	4	Horizontal	208-230/60/1	Left	Straight	\$4,941.93
379961	TCH048AGC10CRSS	4	Horizontal	208-230/60/1	Right	Straight	\$4,941.93
380023	TCH060*FC10CLSS	5	Horizontal	460/60/3	Left	Straight	\$5,621.62
380025	TCH060*FC10CRSS	5	Horizontal	460/60/3	Right	Straight	\$5,621.62
380039	TCH060*HC10CLSS	5	Horizontal	208-230/60/3	Left	Straight	\$5,527.98
380041	TCH060*HC10CRSS	5	Horizontal	208-230/60/3	Right	Straight	\$5,527.98

GEOTHERMAL EQUIPMENT

GEOTHERMAL EQUIPMENT

ClimateMaster-Residential

Tranquility TBW (for Closed Loop Installations)

Water to Water



- 16.4 EER/3.1 COP
- ENERGY STAR® rated
- Single-stage compressor
- Source & load heat exchangers are stainless steel brazed plate
- Generates chilled or hot water
- Closed loop installations only
- Standard 10 year limited warranty on all parts with 5 year labor allowance
- Optional extended 5 year limited labor allowance available for a total of 10 year labor allowance
- Made in the USA

HVAC No.	MFG Part No.	Cooling Cap	Heating Cap	Hot H2O Gen	Outdoor Coil	Price
451650	TBW036AGD00B0BS	30,400 BTUH	26,900 BTUH	No	Copper	\$8,526.11
451651	TBW036AGD01B0BS	30,400 BTUH	26,900 BTUH	Yes	Copper	\$8,962.17
451652	TBW060AGD00B0BS	56,700 BTUH	47,100 BTUH	No	Copper	\$10,140.71
450543	TBW060AGD01B0BS	56,700 BTUH	47,100 BTUH	Yes	Copper	\$11,463.08
451653	TBW120AGD00B0BS	113,400 BTUH	94,200 BTUH	No	Copper	\$22,664.38
451654	TBW120AGD01B0BS	113,400 BTUH	94,200 BTUH	Yes	Copper	\$23,467.67

Tranquility TCW (for Open Loop Installations)

Water to Water



- 23.1 EER/4.0 COP
- ENERGY STAR® rated
- Single-stage compressor
- Source & load heat exchangers are coaxial cupro-nickel
- Generates chilled or hot water
- Optional external flow control
- Open loop installations only
- Standard 10 year limited warranty on all parts with 5 -year labor allowance
- Optional extended 5 year limited labor allowance available for a total of 10 year labor allowance
- Made in the USA

HVAC No.	MFG Part No.	Cooling Cap	Heating Cap	Hot H2O Gen	Outdoor Coil	Price
451655	TCW036AGC00N0CS	35,600 BTUH	34,700 BTUH	No	Cupro-Nickel	\$8,848.69
451656	TCW036AGC01N0CS	35,600 BTUH	34,700 BTUH	Yes	Cupro-Nickel	\$9,650.87
451657	TCW060AGC00N0CS	60,900 BTUH	58,600 BTUH	No	Cupro-Nickel	\$10,879.97
451658	TCW060AGC01N0CS	60,900 BTUH	58,600 BTUH	Yes	Cupro-Nickel	\$11,682.15
451659	TCW120AGC00N0CS	121,800 BTUH	117,200 BTUH	No	Cupro-Nickel	\$24,142.90
451660	TCW120AGC01N0CS	121,800 BTUH	117,200 BTUH	Yes	Cupro-Nickel	\$26,130.78
451651	TCW036AGC00N0NS	35,600 BTUH	34,700 BTUH	No	Cupro-Nickel	\$8,962.17
451662	TCW036AGC01N0NS	35,600 BTUH	34,700 BTUH	Yes	Cupro-Nickel	\$10,340.69
451663	TCW060AGC00N0NS	60,900 BTUH	58,600 BTUH	No	Cupro-Nickel	\$11,618.12
451664	TCW060AGC01N0NS	60,900 BTUH	58,600 BTUH	Yes	Cupro-Nickel	\$12,421.42
451665	TCW120AGC00N0NS	121,800 BTUH	117,200 BTUH	No	Cupro-Nickel	\$25,621.43
451666	TCW120AGC01N0NS	121,800 BTUH	117,200 BTUH	Yes	Cupro-Nickel	\$27,679.53

Tranquility 20 Single Stage

Horizontal Installation



- 21.9 EER/4.3 COP
- ENERGY STAR® rated
- Part-time hot water generation
- External, fixed-speed water flow control
- Standard 10 year limited warranty on all parts with 5 year labor allowance
- Optional extended 5 year limited labor allowance available for a total of 10 year labor allowance
- Made in the USA

HVAC No.	MFG Part No.	Tons A/C	Return	Supply	Hot H2O Gen	Indoor Coil	Price
361887	TSH018BGC00ALBS	1.5	Left	Back	No	Copper	\$7,465.67

GEOHERMAL EQUIPMENT

ClimateMaster-Residential

Tranquility 20 Single Stage

Horizontal Installation

HVAC No.	MFG Part No.	Tons A/C	Return	Supply	Hot H2O Gen	Indoor Coil	Price
361888	TSH018BGC00ARBS	1.5	Right	Back	No	Copper	\$7,465.67
362109	TSH018BGC01ALBS	2.5	Left	Back	Yes	Copper	\$8,306.05
362110	TSH018BGC01ARBS	2.5	Right	Back	Yes	Copper	\$8,064.48
362010	TSH024AGC00ALBS	2	Left	Back	No	Copper	\$7,545.43
362011	TSH024AGC00ARBS	2	Right	Back	No	Copper	\$7,545.43
362309	TSH024AGC01ALBS	2	Left	Back	Yes	Copper	\$8,362.22
362310	TSH024AGC01ARBS	2	Right	Back	Yes	Copper	\$8,362.22
362093	TSH030AGC00ALBS	2.5	Left	Back	No	Copper	\$7,835.29
362094	TSH030AGC00ARBS	2.5	Right	Back	No	Copper	\$7,835.29
362433	TSH030AGC01ALBS	2.5	Left	Back	Yes	Copper	\$8,318.39
362434	TSH030AGC01ARBS	2.5	Right	Back	Yes	Copper	\$8,318.39
362258	TSH036AGC00ALBS	3	Left	Back	No	Copper	\$8,308.29
362259	TSH036AGC00ARBS	3	Right	Back	No	Copper	\$8,308.29
362603	TSH036AGC01ALBS	3	Left	Back	Yes	Copper	\$9,123.95
362604	TSH036AGC01ARBS	3	Right	Back	Yes	Copper	\$9,123.95
362816	TSH042AGC00ALBS	2.5	Left	Back	No	Copper	\$9,735.14
362817	TSH042AGC00ARBS	2.5	Right	Back	No	Copper	\$9,735.14
363115	TSH042AGC01ALBS	3.5	Left	Back	Yes	Copper	\$10,550.80
363116	TSH042AGC01ARBS	3.5	Right	Back	Yes	Copper	\$10,550.80
362904	TSH048AGC00ALBS	4	Left	Back	No	Copper	\$9,917.15
362905	TSH048AGC00ARBS	4	Right	Back	No	Copper	\$9,917.15
363203	TSH048AGC01ALBS	4	Left	Back	Yes	Copper	\$10,732.81
363204	TSH048AGC01ARBS	4	Right	Back	Yes	Copper	\$10,732.81
363283	TSH060AGC00ALBS	5	Left	Back	No	Copper	\$11,115.91
363284	TSH060AGC00ARBS	5	Right	Back	No	Copper	\$11,115.91
363558	TSH060AGC01ALBS	5	Left	Back	Yes	Copper	\$11,931.57
363559	TSH060AGC01ARBS	5	Right	Back	Yes	Copper	\$11,931.57
363445	TSH070AGC00ALBS	6	Left	Back	No	Copper	\$11,667.56
363446	TSH070AGC00ARBS	6	Right	Back	No	Copper	\$11,667.56
363671	TSH070AGC01ARBS	6	Right	Back	Yes	Copper	\$12,484.33

Tranquility 20 Single Stage Horizontal

Auxiliary Heaters

HVAC No.	MFG Part No.	Description	Size	Price
418812	AGM04AAG	Fits TSH018, TSH024, TSH030	4 KW	\$285.37
361735	AGM05AAG	Fits TSH018, TSH024, TSH030	5 KW	\$377.50
361738	AGM08AAG	Fits TSH024, TSH030	8 KW	\$428.06
361739	AGM10AAG	Fits TSH024, TSH030	10 KW	\$447.15
361741	AGL10AAG	Fits TSH036, TSH042, TSH048, TSH060, TSH070	10 KW	\$467.38
361751	AGL15AAG	Fits TSH036, TSH042, TSH048, TSH060, TSH070	15 KW	\$740.40
361752	AGL20AAG	Fits TSH042, TSH048, TSH060, TSH070	20 KW	\$806.67

GEOHERMAL EQUIPMENT

GEOTHERMAL EQUIPMENT

ClimateMaster-Residential

Tranquility 20 Single Stage

Vertical Installation



- 21.9 EER/4.3 COP
- ENERGY STAR® rated
- Part-time hot water generation
- External, fixed-speed water flow control
- Available in vertical upflow or downflow configurations
- Standard 10 year limited warranty on all parts with 5 year labor allowance
- Optional extended 5 year limited labor allowance available for a total of 10 year labor allowance
- Made in the USA

HVAC No.	MFG Part No.	Tons A/C	Return	Supply	Hot H2O Gen	Indoor Coil	Price
362120	TSV018BGC00ARKS	1.5	Right	top	No	Copper	\$8,479.07
362474	TSV018BGC01ALKS	1.5	Left	top	Yes	Copper	\$9,320.56
362475	TSV018BGC01ARKS	1.5	Right	top	Yes	Copper	\$9,320.56
362343	TSV024AGC00ALKS	2	Left	top	No	Copper	\$8,530.75
362344	TSV024AGC00ARKS	2	Right	top	No	Copper	\$8,530.75
362720	TSV024AGC01ALKS	2	Left	top	Yes	Copper	\$9,346.41
362721	TSV024AGC01ARKS	2	Right	top	Yes	Copper	\$9,346.41
362458	TSV030AGC00ALKS	2.5	Left	top	No	Copper	\$8,819.48
362459	TSV030AGC00ARKS	2.5	Right	top	No	Copper	\$8,819.48
362792	TSV030AGC01ALKS	2.5	Left	top	Yes	Copper	\$9,635.14
362793	TSV030AGC01ARKS	2.5	Right	top	Yes	Copper	\$9,635.14
362629	TSV036AGC00ALKS	3	Left	top	No	Copper	\$9,292.48
362630	TSV036AGC00ARKS	3	Right	top	No	Copper	\$9,292.48
362946	TSV036AGC01ALKS	3	Left	top	Yes	Copper	\$10,109.25
362947	TSV036AGC01ARKS	3	Right	top	Yes	Copper	\$10,109.25
363155	TSV042AGC00ALKS	3.5	Left	top	No	Copper	\$10,720.44
363156	TSV042AGC00ARKS	3.5	Right	top	No	Copper	\$10,720.44
363421	TSV042AGC01ALKS	3.5	Left	top	Yes	Copper	\$11,536.10
363422	TSV042AGC01ARKS	3.5	Right	top	Yes	Copper	\$11,536.10
363243	TSV048AGC00ALKS	4	Left	top	No	Copper	\$11,099.07
363244	TSV048AGC00ARKS	4	Right	top	No	Copper	\$11,099.07
363518	TSV048AGC01ALKS	4	Left	top	Yes	Copper	\$11,913.59
363519	TSV048AGC01ARKS	4	Right	top	Yes	Copper	\$11,913.59
363590	TSV060AGC00ALKS	5	Left	top	No	Copper	\$12,297.83
363591	TSV060AGC00ARKS	5	Right	top	No	Copper	\$12,297.83
363791	TSV060AGC01ALKS	5	Left	top	Yes	Copper	\$13,113.49
363792	TSV060AGC01ARKS	5	Right	top	Yes	Copper	\$13,113.49
363735	TSV070AGC00ALKS	6	Left	top	No	Copper	\$12,848.35
363736	TSV070AGC00ARKS	6	Right	top	No	Copper	\$12,848.35
363874	TSV070AGC01ALKS	6	Left	top	Yes	Copper	\$13,667.39
363875	TSV070AGC01ARKS	6	Right	top	Yes	Copper	\$13,667.39

Tranquility 20 Single Stage Vertical

Auxiliary Heaters

HVAC No.	MFG Part No.	Description	Size	Price
418812	AGM04AAG	Fits TSV018, TSV024, TSV030	4 KW	\$285.37
361735	AGM05AAG	Fits TSV018, TSV024, TSV030	5 KW	\$377.50
361738	AGM08AAG	Fits TSV024, TSV030	8 KW	\$428.06
361739	AGM10AAG	Fits TSV024, TSV030	10 KW	\$447.15
361741	AGL10AAG	Fits TSV036, TSV042, TSV048, TSV060, TSV070	10 KW	\$467.38
361751	AGL15AAG	Fits TSV036, TSV042, TSV048, TSV060, TSV070	15 KW	\$740.40
361752	AGL20AAG	Fits TSV042, TSV048, TSV060, TSV070	20 KW	\$806.67

GEOTHERMAL EQUIPMENT

GEOTHERMAL EQUIPMENT

ClimateMaster-Residential

Trilogy 45 Inverter

Horizontal Installation



- Exclusively available for ClimateMaster GeoElite Dealers
- 45 EER/5.1 COP
- Most efficient ENERGY STAR® designation
- Field convertible discharge
- iGate™ connect communicating system
- Dedicated, full-time hot water generation with Q-Mode™ (free hot water generation during cooling periods)
- Internal, variable speed water flow control
- Standard 10 year limited warranty on all parts with 5 year labor allowance
- Optional extended 5 year limited labor allowance available for a total of 10 year labor allowance
- GeoElite includes Homeowner 100% Satisfaction Guarantee on first year of installation
- Made in the USA

HVAC No.	MFG Part No.	Cooling Cap	Heating Cap	Configuration	Return	Supply	Price
418798	QEH0930AGE02BLS	9-24 MBH	12-30 MBH	Straight	Left	Side	\$19,291.63
418799	QEH0930AGE02BRS	9-24 MBH	12-30 MBH	Straight	Right	Side	\$18,729.88
418800	QEB0930AGE02BLS	9-24 MBH	12-30 MBH	Back	Left	End	\$17,880.51
418801	QEB0930AGE02BRS	9-24 MBH	12-30 MBH	Back	Right	End	\$17,880.51
418806	QEH1860AGE02BLS	18-48 MBH	24-60 MBH	Straight	Left	Side	\$23,154.22
418807	QEH1860AGE02BRS	18-48 MBH	24-60 MBH	Straight	Right	Side	\$22,478.99
418808	QEB1860AGE02BLS	18-48 MBH	24-60 MBH	Back	Left	End	\$22,104.87
418809	QEB1860AGE02BRS	18-48 MBH	24-60 MBH	Back	Right	End	\$21,458.85

Vertical Installation



- Exclusively available for ClimateMaster GeoElite Dealers
- 45 EER/5.1 COP
- Most efficient ENERGY STAR® designation
- Available in vertical upflow or downflow Configurations
- iGate™ connect communicating system
- Dedicated, full-time hot water generation with Q-Mode™ (free hot water generation during cooling periods)
- Internal, variable speed water flow control (vFlow™) standard
- Standard 10 year limited warranty on all parts with 5 year labor allowance
- Optional extended 5 year limited labor allowance available for a total of 10 year labor allowance
- GeoElite includes Homeowner 100% Satisfaction Guarantee on first year of installation
- Made in the USA

HVAC No.	MFG Part No.	Cooling Cap	Heating Cap	Configuration	Return	Supply	Price
418796	QEV0930AGE02BLS	9-24 MBH	12-30 MBH	Vertical	Left	Top	\$19,291.63
418797	QEV0930AGE02BRS	9-24 MBH	12-30 MBH	Vertical	Right	Top	\$19,291.63
418802	QED0930AGE02BLS	9-24 MBH	12-30 MBH	Downflow	Left	Bottom	\$18,416.41
418803	QED0930AGE02BRS	9-24 MBH	12-30 MBH	Downflow	Right	Bottom	\$18,416.41
418804	QEV1860AGE02BLS	18-48 MBH	24-60 MBH	Vertical	Left	Top	\$23,154.22
418805	QEV1860AGE02BRS	18-48 MBH	24-60 MBH	Vertical	Right	Top	\$23,154.22
418810	QED1860AGE02BLS	18-48 MBH	24-60 MBH	Downflow	Left	Bottom	\$22,104.87
418811	QED1860AGE02BRS	18-48 MBH	24-60 MBH	Downflow	Right	Bottom	\$22,104.87

Trilogy 45 Inverter Accessories

Auxiliary Heaters

HVAC No.	MFG Part No.	Description	Size	Price
418812	AGM04AAG	Fits QEV0930, QED0930	4 KW	\$285.37
361735	AGM05AAG	Fits QEV0930, QED0930	5 KW	\$377.50
361738	AGM08AAG	Fits QEV0930, QED0930	8 KW	\$428.06
361739	AGM10AAG	Fits QEV0930, QED0930	10 KW	\$447.15
361741	AGL10AAG	Fits QEHV860, QED1860	10 KW	\$467.38
361751	AGL15AAG	Fits QEHV860, QED1860	15 KW	\$740.40
361752	AGL20AAG	Fits QEHV860, QED1860	20 KW	\$806.67

GEOTHERMAL EQUIPMENT

ClimateMaster-Residential

Trilogy 45 Inverter Accessories

Water Heater / Storage Tank

HVAC No.	MFG Part No.	Description	Price
447911	AWS050AW12455A	50 Gallon Communicating	\$2,197.13

Tranquility 30 Two Stage Digital

Vertical Installation, Internal Pump for Closed Loop



- 29.6 EER/5.0 COP
- Most efficient ENERGY STAR® designation
- Available in vertical upflow or downflow configurations
- iGate™ communicating system
- Copper water coil
- Part-time hot water generation
- Internal, variable speed water flow control (vFlow™) included
- Standard 10 year limited warranty on all parts with 5 year labor allowance
- Optional extended 5 year limited labor allowance available for a total of 10 year labor allowance
- Made in the USA

HVAC No.	MFG Part No.	Tons A/C	Return	Supply	Hot H2O Gen	Indoor Coil	Price
423024	TEV026BGD02CLTS	2	Left	Top	Yes	Copper	\$12,922.50
423025	TEV026BGD02CRTS	2	Right	Top	Yes	Copper	\$12,922.50
423026	TEV038BGD02CLTS	3	Left	Top	Yes	Copper	\$14,105.55
423027	TEV038BGD02CRTS	3	Right	Top	Yes	Copper	\$14,105.55
423009	TEV049BGD02CLTS	4	Left	Top	Yes	Copper	\$15,527.90
423028	TEV049BGD02CRTS	4	Right	Top	Yes	Copper	\$15,527.90
423029	TEV064BGD02CLTS	5	Left	Top	Yes	Copper	\$16,804.20
423030	TEV064BGD02CRTS	5	Right	Top	Yes	Copper	\$14,570.79
423031	TEV072BGD02CLTS	6	Left	Top	Yes	Copper	\$17,253.60
423032	TEV072BGD02CRTS	6	Right	Top	Yes	Copper	\$17,253.60
423043	TEV026BGD02ALTS	2	Left	Top	No	Copper	\$12,081.01
423044	TEV026BGD02ARTS	2	Right	Top	No	Copper	\$12,081.01
423045	TEV038BGD02ALTS	3	Left	Top	No	Copper	\$13,265.18
423046	TEV038BGD02ARTS	3	Right	Top	No	Copper	\$13,265.18
423047	TEV049BGD02ALTS	4	Left	Top	No	Copper	\$14,687.53
423048	TEV049BGD02ARTS	4	Right	Top	No	Copper	\$14,687.53
423049	TEV064BGD02ALTS	5	Left	Top	No	Copper	\$15,962.69
423050	TEV064BGD02ARTS	5	Right	Top	No	Copper	\$15,962.69
423051	TEV072BGD02ALTS	6	Left	Top	No	Copper	\$16,412.09
423052	TEV072BGD02ARTS	6	Right	Top	No	Copper	\$15,935.72

Tranquility 30 Two Stage Digital

Auxiliary Heaters for TEV

HVAC No.	MFG Part No.	Description	Size	Price
418812	AGM04AAG	Fits TEV026	4 KW	\$285.37
361735	AGM05AAG	Fits TEV026	5 KW	\$377.50
361738	AGM08AAG	Fits TEV026	8 KW	\$428.06
361739	AGM10AAG	Fits TEV026	10 KW	\$447.15
361741	AGL10AAG	Fits TEV038, TEV049, TEV064, TEV072	10 KW	\$467.38
361751	AGL15AAG	Fits TEV038, TEV049, TEV064, TEV072	15 KW	\$740.40
361752	AGL20AAG	Fits TEV049, TEV064, TEV072	20 KW	\$806.67

GEOTHERMAL EQUIPMENT

GEOTHERMAL EQUIPMENT

ClimateMaster-Residential

Tranquility 30 Two Stage Digital

Vertical Installation, Modulating Valve for Open Loop



- 29.6 EER/5.0 COP
- Most efficient ENERGY STAR® designation
- Available in vertical upflow or downflow Configurations
- iGate™ communicating system
- Cupro-nickel water coil
- Part-time hot water generation
- Internal, variable water flow control valve included
- Standard 10 year limited warranty on all parts with 5 year labor allowance
- Optional extended 5 year limited labor allowance available for a total of 10 year labor allowance
- Made in the USA

HVAC No.	MFG Part No.	Tons A/C	Return	Supply	Hot H2O Gen	Indoor Coil	Price
423033	TEV026BGD06NLTS	2	Left	Top	Yes	Cupro-Nickel	\$11,451.85
423034	TEV026BGD06NRTS	2	Right	Top	Yes	Cupro-Nickel	\$11,451.85
423035	TEV038BGD06NLTS	3	Left	Top	Yes	Cupro-Nickel	\$12,550.63
423036	TEV038BGD06NRTS	3	Right	Top	Yes	Cupro-Nickel	\$12,550.63
423037	TEV049BGD06NLTS	4	Left	Top	Yes	Cupro-Nickel	\$13,981.97
423038	TEV049BGD06NRTS	4	Right	Top	Yes	Cupro-Nickel	\$13,981.97
423039	TEV064BGD06NLTS	5	Left	Top	Yes	Cupro-Nickel	\$15,421.16
423040	TEV064BGD06NRTS	5	Right	Top	Yes	Cupro-Nickel	\$15,421.16
423041	TEV072BGD06NLTS	6	Left	Top	Yes	Cupro-Nickel	\$15,871.70
423042	TEV072BGD06NRTS	6	Right	Top	No	Cupro-Nickel	\$15,871.70

Tranquility 30 Two Stage Digital

Auxiliary Heaters for Vertical Installation, Modulating Valve for Open Loop

HVAC No.	MFG Part No.	Description	Size	Price
418812	AGM04AAG	Fits TEV026	4 KW	\$285.37
361735	AGM05AAG	Fits TEV026	5 KW	\$377.50
361738	AGM08AAG	Fits TEV026	8 KW	\$428.06
361739	AGM10AAG	Fits TEV026	10 KW	\$447.15
361741	AGL10AAG	Fits TEV038, TEV049, TEV064, TEV072	10 KW	\$467.38
361751	AGL15AAG	Fits TEV038, TEV049, TEV064, TEV072	15 KW	\$740.40
361752	AGL20AAG	Fits TEV049, TEV064, TEV072	20 KW	\$806.67

Tranquility 22 Two Stage Digital

Vertical Installation, Internal Pump for Closed Loop



- 23.7 EER/4.1 COP
- Most efficient ENERGY STAR® designation
- Available in vertical upflow configuration
- iGate™ communicating system
- Copper water coil
- Part-time hot water generation
- Internal, variable speed water flow control (vFlow™) included
- Standard 10 year limited warranty on all parts with 5 year labor allowance
- Optional extended 5 year limited labor allowance available for a total of 10 year labor allowance
- Made in the USA

HVAC No.	MFG Part No.	Tons A/C	Return	Supply	Hot H2O Gen	Indoor Coil	Price
450337	TZV024CGD02ALTS	2	Left	Top	No	Copper	\$9,054.30
450341	TZV024CGD02ARTS	2	Right	Top	No	Copper	\$9,054.30
448762	TZV024CGD02CLTS	2	Left	Top	Yes	Copper	\$9,894.68
450342	TZV024CGD02CRTS	2	Right	Top	Yes	Copper	\$9,894.68
450345	TZV030CGD02ALTS	2.5	Left	Top	No	Copper	\$9,096.99
450346	TZV030CGD02ARTS	2.5	Right	Top	No	Copper	\$9,096.99
448863	TZV030CGD02CLTS	2.5	Left	Top	Yes	Copper	\$10,186.87
450031	TZV030CGD02CRTS	2.5	Right	Top	Yes	Copper	\$9,938.48

GEOTHERMAL EQUIPMENT

GEOTHERMAL EQUIPMENT

ClimateMaster-Residential

Tranquility 22 Two Stage Digital

Vertical Installation, Internal Pump for Closed Loop

HVAC No.	MFG Part No.	Tons A/C	Return	Supply	Hot H2O Gen	Indoor Coil	Price
450351	TZV036CGD02ALTS	3	Left	Top	No	Copper	\$9,652.00
450352	TZV036CGD02ARTS	3	Right	Top	No	Copper	\$9,652.00
450030	TZV036CGD02CLTS	3	Left	Top	Yes	Copper	\$10,493.49
448763	TZV036CGD02CRTS	3	Right	Top	Yes	Copper	\$10,756.24
450354	TZV042CGD02ALTS	3.5	Left	Top	No	Copper	\$10,149.70
450336	TZV042CGD02ARTS	3.5	Right	Top	No	Copper	\$10,149.70
450355	TZV042CGD02CLTS	3.5	Left	Top	Yes	Copper	\$11,267.78
450356	TZV042CGD02CRTS	3.5	Right	Top	Yes	Copper	\$10,990.08
450359	TZV048CGD02ALTS	4	Left	Top	No	Copper	\$10,678.88
450360	TZV048CGD02ARTS	4	Right	Top	No	Copper	\$10,678.88
448865	TZV048CGD02CLTS	4	Left	Top	Yes	Copper	\$11,812.14
448764	TZV048CGD02CRTS	4	Right	Top	Yes	Copper	\$11,520.37
450362	TZV060CGD02ALTS	5	Left	Top	No	Copper	\$11,409.15
450363	TZV060CGD02ARTS	5	Right	Top	No	Copper	\$11,409.15
448472	TZV060CGD02CLTS	5	Left	Top	Yes	Copper	\$12,561.65
448873	TZV060CGD02CRTS	5	Right	Top	Yes	Copper	\$12,250.64

Auxiliary Heaters for Vertical Installation, Internal Pump for Closed Loop

HVAC No.	MFG Part No.	Description	Size	Price
418812	AGM04AAG	Fits TZV024, TZV030, TZV036, TZV042	4 KW	\$285.37
361735	AGM05AAG	Fits TZV024, TZV030, TZV036, TZV042	5 KW	\$377.50
361738	AGM08AAG	Fits TZV024, TZV030, TZV036, TZV042	8 KW	\$428.06
361739	AGM10AAG	Fits TZV024, TZV030, TZV036, TZV042	10 KW	\$447.15
361749	AGM12AAG	Fits TZV030, TZV036, TZV042	12 KW	\$635.90
361741	AGL10AAG	Fits TZV048, TZV060	10 KW	\$467.38
361751	AGL15AAG	Fits TZV048, TZV060	15 KW	\$740.40
361752	AGL20AAG	Fits TZV048, TZV060	20 KW	\$806.67

Vertical Installation, Modulating Valve for Closed Loop



- 23.7 EER/4.1 COP
- Most efficient ENERGY STAR® designation
- Available in vertical upflow configuration
- iGate™ communicating system
- Copper water coil
- Part-time hot water generation
- Internal, variable water flow control valve included
- Standard 10 year limited warranty on all parts with 5 year labor allowance
- Optional extended 5 year limited labor allowance available for a total of 10 year labor allowance
- Made in the USA

HVAC No.	MFG Part No.	Tons A/C	Return	Supply	Hot H2O Gen	Indoor Coil	Price
450187	TZV024CGD05ARTS	2	Right	Top	No	Copper	\$7,172.42
450186	TZV024CGD05CLTS	2	Left	Top	Yes	Copper	\$8,013.94
450188	TZV024CGD05ALTS	2	Left	Top	No	Copper	\$7,172.42
450185	TZV024CGD05CRTS	2	Right	Top	Yes	Copper	\$8,013.94
450378	TZV030CGD05ALTS	2.5	Left	Top	No	Copper	\$7,227.49
450379	TZV030CGD05ARTS	2.5	Right	Top	No	Copper	\$7,227.49
450376	TZV030CGD05CLTS	2.5	Left	Top	Yes	Copper	\$8,067.86
450377	TZV030CGD05CRTS	2.5	Right	Top	Yes	Copper	\$8,067.86
450181	TZV036CGD05ALTS	3	Left	Top	No	Copper	\$7,776.87
450180	TZV036CGD05ARTS	3	Right	Top	No	Copper	\$7,776.87
450179	TZV036CGD05CLTS	3	Left	Top	Yes	Copper	\$8,617.25
450178	TZV036CGD05CRTS	3	Right	Top	Yes	Copper	\$8,617.25
450382	TZV042CGD05ALTS	3.5	Left	Top	No	Copper	\$8,273.45
450383	TZV042CGD05ARTS	3.5	Right	Top	No	Copper	\$8,273.45

GEOTHERMAL EQUIPMENT

GEOTHERMAL EQUIPMENT

ClimateMaster-Residential

Tranquility 22 Two Stage Digital

Vertical Installation, Modulating Valve for Closed Loop

HVAC No.	MFG Part No.	Tons A/C	Return	Supply	Hot H2O Gen	Indoor Coil	Price
450380	TZV042CGD05CLTS	3.5	Left	Top	Yes	Copper	\$9,114.97
450381	TZV042CGD05CRTS	3.5	Right	Top	Yes	Copper	\$9,114.97
450388	TZV048CGD05ALTS	4	Left	Top	No	Copper	\$8,652.08
450389	TZV048CGD05ARTS	4	Right	Top	No	Copper	\$8,652.08
450386	TZV048CGD05CLTS	4	Left	Top	Yes	Copper	\$9,492.46
450387	TZV048CGD05CRTS	4	Right	Top	Yes	Copper	\$9,492.46
450175	TZV060CGD05ALTS	5	Left	Top	No	Copper	\$9,514.93
450173	TZV060CGD05ARTS	5	Right	Top	No	Copper	\$9,514.93
450171	TZV060CGD05CLTS	5	Left	Top	Yes	Copper	\$10,356.42
450170	TZV060CGD05CRTS	5	Right	Top	Yes	Copper	\$10,356.42

Auxiliary Heaters for Vertical Installation, Modulating Valve for Closed Loop

HVAC No.	MFG Part No.	Description	Size	Price
100000000	418812	AGM04AAG	Fits TZV024, TZV030, TZV036, TZV042	4 KW \$285.37
000	361735	AGM05AAG	Fits TZV024, TZV030, TZV036, TZV042	5 KW \$377.50
000	361738	AGM08AAG	Fits TZV024, TZV030, TZV036, TZV042	8 KW \$428.06
000	361739	AGM10AAG	Fits TZV024, TZV030, TZV036, TZV042	10 KW \$447.15
000	361749	AGM12AAG	Fits TZV030, TZV036, TZV042	12 KW \$635.90
000	361741	AGL10AAG	Fits TZV048, TZV060	10 KW \$467.38
000	361751	AGL15AAG	Fits TZV048, TZV060	15 KW \$740.40
000	361752	AGL20AAG	Fits TZV048, TZV060	20 KW \$806.67

Vertical Installation, Modulating Valve for Open Loop



- 23.7 EER/4.1 COP
- Most efficient ENERGY STAR® designation
- Available in vertical upflow configuration
- iGate™ communicating system
- Cupro-nickel water coil
- Part-time hot water generation
- Internal, variable water flow control valve included
- Standard 10 year limited warranty on all parts with 5 year labor allowance
- Optional extended 5 year limited labor allowance available for a total of 10 year labor allowance
- Made in the USA

HVAC No.	MFG Part No.	Tons A/C	Return	Supply	Hot H2O Gen	Indoor Coil	Price
450183	TZV024CGD06JLTS	2	Left	Top	No	Cupro-Nickel	\$7,367.91
450182	TZV024CGD06JRTS	2	Right	Top	No	Cupro-Nickel	\$7,367.91
450343	TZV024CGD06NLTS	2	Left	Top	Yes	Cupro-Nickel	\$8,209.43
450339	TZV024CGD06NRTS	2	Right	Top	Yes	Cupro-Nickel	\$8,209.43
450347	TZV030CGD06JLTS	2.5	Left	Top	No	Cupro-Nickel	\$7,411.74
450348	TZV030CGD06JRTS	2.5	Right	Top	No	Cupro-Nickel	\$7,411.74
449983	TZV030CGD06NLTS	2.5	Left	Top	Yes	Cupro-Nickel	\$8,252.12
450349	TZV030CGD06NRTS	2.5	Right	Top	Yes	Cupro-Nickel	\$8,252.12
450177	TZV036CGD06JLTS	3	Left	Top	No	Cupro-Nickel	\$7,958.87
450176	TZV036CGD06JRTS	3	Right	Top	No	Cupro-Nickel	\$7,958.87
448864	TZV036CGD06NLTS	3	Left	Top	Yes	Cupro-Nickel	\$8,799.25
450350	TZV036CGD06NRTS	3	Right	Top	Yes	Cupro-Nickel	\$8,799.25
450384	TZV042CGD06JLTS	3.5	Left	Top	No	Cupro-Nickel	\$9,081.26
450385	TZV042CGD06JRTS	3.5	Right	Top	No	Cupro-Nickel	\$9,081.26
450357	TZV042CGD06NLTS	3.5	Left	Top	Yes	Cupro-Nickel	\$9,922.75
450358	TZV042CGD06NRTS	3.5	Right	Top	Yes	Cupro-Nickel	\$9,922.75
450390	TZV048CGD06JLTS	4	Left	Top	No	Cupro-Nickel	\$9,521.67
450391	TZV048CGD06JRTS	4	Right	Top	No	Cupro-Nickel	\$9,521.67
449959	TZV048CGD06NLTS	4	Left	Top	Yes	Cupro-Nickel	\$10,363.16
450361	TZV048CGD06NRTS	4	Right	Top	Yes	Cupro-Nickel	\$10,363.16

GEOTHERMAL EQUIPMENT

GEOTHERMAL EQUIPMENT

ClimateMaster-Residential

Tranquility 22 Two Stage Digital

Vertical Installation, Modulating Valve for Open Loop

HVAC No.	MFG Part No.	Tons A/C	Return	Supply	Hot H2O Gen	Indoor Coil	Price
450169	TZV060CGD06JLTS	5	Left	Top	No	Cupro-Nickel	\$10,508.11
450168	TZV060CGD06JRTS	5	Right	Top	No	Cupro-Nickel	\$10,508.11
449960	TZV060CGD06NLTS	5	Left	Top	Yes	Cupro-Nickel	\$11,348.48
450364	TZV060CGD06NRTS	5	Right	Top	Yes	Cupro-Nickel	\$10,912.73

Auxiliary Heaters for Vertical Installation, Modulating Valve for Open Loop

HVAC No.	MFG Part No.	Description	Size	Price
100 000 000	418812	AGM04AAG	Fits TZV024, TZV030, TZV036, TZV042	4 KW \$285.37
000	361735	AGM05AAG	Fits TZV024, TZV030, TZV036, TZV042	5 KW \$377.50
000	361738	AGM08AAG	Fits TZV024, TZV030, TZV036, TZV042	8 KW \$428.06
000	361739	AGM10AAG	Fits TZV024, TZV030, TZV036, TZV042	10 KW \$447.15
000	361749	AGM12AAG	Fits TZV030, TZV036, TZV042	12 KW \$635.90
000	361741	AGL10AAG	Fits TZV048, TZV060	10 KW \$467.38
000	361751	AGL15AAG	Fits TZV048, TZV060	15 KW \$740.40
000	361752	AGL20AAG	Fits TZV048, TZV060	20 KW \$806.67

Horizontal Installation, Internal Pump for Closed Loop



- 23.7 EER/4.1 COP
- Most efficient ENERGY STAR® designation
- Field convertible discharge
- iGate™ communicating system
- Copper water coil
- Part-time hot water generation
- Internal, variable speed water flow control (vFlow™) included
- Standard 10 year limited warranty on all parts with 5-year labor allowance
- Optional extended 5 year limited labor allowance available for a total of 10 year labor allowance
- Made in the USA

HVAC No.	MFG Part No.	Tons A/C	Return	Supply	Hot H2O Gen	Indoor Coil	Price
450260	TZH024CGD02ALBS	2	Left	Back	No	Copper	\$9,325.05
450259	TZH024CGD02ALSS	2	Left	Straight	No	Copper	\$9,325.05
450258	TZH024CGD02ARBS	2	Right	Back	No	Copper	\$9,325.05
450257	TZH024CGD02ARSS	2	Right	Straight	No	Copper	\$9,325.05
450256	TZH024CGD02CLBS	2	Left	Back	Yes	Copper	\$10,166.56
450255	TZH024CGD02CLSS	2	Left	Straight	Yes	Copper	\$10,166.56
450254	TZH024CGD02CRBS	2	Right	Straight	Yes	Copper	\$9,869.96
450253	TZH024CGD02CRSS	2	Right	Straight	Yes	Copper	\$10,166.56
450396	TZH030CGD02ALBS	2.5	Left	Back	No	Copper	\$9,369.99
450398	TZH030CGD02ALSS	2.5	Left	Straight	No	Copper	\$9,369.99
450397	TZH030CGD02ARBS	2.5	Right	Back	No	Copper	\$9,096.99
450399	TZH030CGD02ARSS	2.5	Right	Straight	No	Copper	\$9,369.99
450392	TZH030CGD02CLBS	2.5	Left	Back	Yes	Copper	\$10,211.50
450394	TZH030CGD02CLSS	2.5	Left	Straight	Yes	Copper	\$10,211.50
450393	TZH030CGD02CRBS	2.5	Right	Back	Yes	Copper	\$10,211.50
450395	TZH030CGD02CRSS	2.5	Right	Straight	Yes	Copper	\$10,211.50
450236	TZH036CGD02ALBS	3	Left	Back	No	Copper	\$9,940.73
450235	TZH036CGD02ALSS	3	Left	Straight	No	Copper	\$9,940.73
450233	TZH036CGD02ARSS	3	Right	Straight	No	Copper	\$9,940.73
450234	TZH036CGD02ARBS	3	Right	Back	No	Copper	\$9,940.73
450232	TZH036CGD02CLBS	3	Left	Back	Yes	Copper	\$10,782.24
450231	TZH036CGD02CLSS	3	Left	Straight	Yes	Copper	\$10,782.24
450230	TZH036CGD02CRBS	3	Right	Back	Yes	Copper	\$10,782.24
450229	TZH036CGD02CRSS	3	Right	Straight	Yes	Copper	\$10,782.24
450420	TZH042CGD02ALBS	3.5	Left	Back	No	Copper	\$10,454.18
450422	TZH042CGD02ALSS	3.5	Left	Straight	No	Copper	\$10,454.18

GEOTHERMAL EQUIPMENT

GEOTHERMAL EQUIPMENT

ClimateMaster-Residential

Tranquility 22 Two Stage Digital

Horizontal Installation, Internal Pump for Closed Loop

HVAC No.	MFG Part No.	Tons A/C	Return	Supply	Hot H2O Gen	Indoor Coil	Price
450421	TZH042CGD02ARBS	3.5	Right	Back	No	Copper	\$10,454.18
450423	TZH042CGD02ARSS	3.5	Right	Straight	No	Copper	\$10,454.18
450416	TZH042CGD02CLBS	3.5	Left	Back	Yes	Copper	\$11,294.56
450418	TZH042CGD02CLSS	3.5	Left	Straight	Yes	Copper	\$11,294.56
450417	TZH042CGD02CRBS	3.5	Right	Back	Yes	Copper	\$11,294.56
450419	TZH042CGD02CRSS	3.5	Right	Straight	Yes	Copper	\$11,294.56
450444	TZH048CGD02ALBS	4	Left	Back	No	Copper	\$10,999.07
450446	TZH048CGD02ALSS	4	Left	Straight	No	Copper	\$10,999.07
450445	TZH048CGD02ARBS	4	Right	Back	No	Copper	\$10,999.07
450447	TZH048CGD02ARSS	4	Right	Straight	No	Copper	\$10,999.07
450440	TZH048CGD02CLBS	4	Left	Back	Yes	Copper	\$11,840.58
450442	TZH048CGD02CLSS	4	Left	Straight	Yes	Copper	\$11,840.58
450441	TZH048CGD02CRBS	4	Right	Back	Yes	Copper	\$11,840.58
450443	TZH048CGD02CRSS	4	Right	Straight	Yes	Copper	\$11,840.58
450212	TZH060CGD02ALBS	5	Left	Back	No	Copper	\$11,750.70
450211	TZH060CGD02ALSS	5	Left	Straight	No	Copper	\$11,750.70
450210	TZH060CGD02ARBS	5	Right	Back	No	Copper	\$11,750.70
450209	TZH060CGD02ARSS	5	Right	Straight	No	Copper	\$11,750.70
450208	TZH060CGD02CLBS	5	Left	Back	Yes	Copper	\$12,591.08
450207	TZH060CGD02CLSS	5	Left	Straight	Yes	Copper	\$12,591.08
450206	TZH060CGD02CRBS	5	Right	Back	Yes	Copper	\$12,591.08
450205	TZH060CGD02CRSS	5	Right	Straight	Yes	Copper	\$12,591.08

Auxiliary Heaters for Horizontal Installation, Internal Pump for Closed Loop

HVAC No.	MFG Part No.	Description	Size	Price
361741	AGL10AAG	Fits TZH048, TZH060	10 KW	\$467.38
361749	AGM12AAG	Fits TZH030, TZH036, TZH042	12 KW	\$635.90
361751	AGL15AAG	Fits TZH048, TZH060	15 KW	\$740.40
361752	AGL20AAG	Fits TZH048, TZH060	20 KW	\$806.67

Horizontal Installation, Modulating Valve for Closed Loop



- 23.7 EER/4.1 COP
- Most efficient ENERGY STAR® designation
- Field convertible discharge
- iGate™ communicating system
- Copper water coil
- Part-time hot water generation
- Internal, variable water flow control valve optional
- Standard 10 year limited warranty on all parts with 5 year labor allowance
- Optional extended 5 year limited labor allowance available for a total of 10 year labor allowance
- Made in the USA

HVAC No.	MFG Part No.	Tons A/C	Supply	Hot H2O Gen	Indoor Coil	Return	Price
450252	TZH024CGD05ALBS	2	Back	No	Copper	Left	\$7,365.67
450251	TZH024CGD05ALSS	2	Straight	No	Copper	Left	\$7,365.67
450250	TZH024CGD05ARBS	2	Back	No	Copper	Right	\$7,365.67
450249	TZH024CGD05ARSS	2	Straight	No	Copper	Right	\$7,365.67
450248	TZH024CGD05CLBS	2	Back	Yes	Copper	Left	\$8,042.01
450247	TZH024CGD05CLSS	2	Straight	Yes	Copper	Left	\$8,206.04
450246	TZH024CGD05CRBS	2	Back	Yes	Copper	Right	\$8,206.04
450245	TZH024CGD05CRSS	2	Straight	Yes	Copper	Right	\$8,206.04
450404	TZH030CGD05ALBS	2.5	Back	No	Copper	Left	\$7,227.49
450406	TZH030CGD05ALSS	2.5	Straight	No	Copper	Left	\$7,227.49
450405	TZH030CGD05ARBS	2.5	Back	No	Copper	Right	\$7,410.61
450407	TZH030CGD05ARSS	2.5	Straight	No	Copper	Right	\$7,227.49

GEOHERMAL EQUIPMENT

ClimateMaster-Residential

Tranquility 22 Two Stage Digital

Horizontal Installation, Modulating Valve for Closed Loop

HVAC No.	MFG Part No.	Tons A/C	Supply	Hot H2O Gen	Indoor Coil	Return	Price
450400	TZH030CGD05CLBS	2.5	Back	Yes	Copper	Left	\$8,043.15
450402	TZH030CGD05CLSS	2.5	Straight	Yes	Copper	Left	\$8,250.98
450401	TZH030CGD05CRBS	2.5	Back	Yes	Copper	Right	\$8,043.15
450403	TZH030CGD05CRSS	2.5	Straight	Yes	Copper	Right	\$8,043.15
450228	TZH036CGD05ALBS	3	Back	No	Copper	Left	\$7,898.21
450227	TZH036CGD05ALSS	3	Straight	No	Copper	Left	\$7,898.21
450226	TZH036CGD05ARBS	3	Back	No	Copper	Right	\$7,775.75
450225	TZH036CGD05ARSS	3	Straight	No	Copper	Right	\$7,775.75
450224	TZH036CGD05CLBS	3	Back	Yes	Copper	Left	\$8,592.53
450223	TZH036CGD05CLSS	3	Straight	Yes	Copper	Left	\$8,738.58
450222	TZH036CGD05CRBS	3	Back	Yes	Copper	Right	\$8,738.58
450221	TZH036CGD05CRSS	3	Straight	Yes	Copper	Right	\$8,592.53
450428	TZH042CGD05ALBS	3.5	Back	No	Copper	Left	\$8,273.45
450430	TZH042CGD05ALSS	3.5	Straight	No	Copper	Left	\$8,273.45
450429	TZH042CGD05ARBS	3.5	Back	No	Copper	Right	\$8,273.45
450431	TZH042CGD05ARSS	3.5	Straight	No	Copper	Right	\$8,273.45
450424	TZH042CGD05CLBS	3.5	Back	Yes	Copper	Left	\$9,089.12
450426	TZH042CGD05CLSS	3.5	Straight	Yes	Copper	Left	\$9,249.79
450425	TZH042CGD05CRBS	3.5	Back	Yes	Copper	Right	\$9,089.12
450427	TZH042CGD05CRSS	3.5	Straight	Yes	Copper	Right	\$9,249.79
450452	TZH048CGD05ALBS	4	Back	No	Copper	Left	\$8,730.73
450454	TZH048CGD05ALSS	4	Straight	No	Copper	Left	\$8,730.73
450453	TZH048CGD05ARBS	4	Back	No	Copper	Right	\$8,652.08
450455	TZH048CGD05ARSS	4	Straight	No	Copper	Right	\$8,652.08
450448	TZH048CGD05CLBS	4	Back	Yes	Copper	Left	\$9,467.75
450450	TZH048CGD05CLSS	4	Straight	Yes	Copper	Left	\$9,572.22
450449	TZH048CGD05CRBS	4	Back	Yes	Copper	Right	\$9,467.75
450451	TZH048CGD05CRSS	4	Straight	Yes	Copper	Right	\$9,572.22
450204	TZH060CGD05ALBS	5	Back	No	Copper	Left	\$9,594.69
450203	TZH060CGD05ALSS	5	Straight	No	Copper	Left	\$9,594.69
450202	TZH060CGD05ARBS	5	Back	No	Copper	Right	\$9,594.69
450201	TZH060CGD05ARSS	5	Straight	No	Copper	Right	\$9,594.69
450200	TZH060CGD05CLBS	5	Back	Yes	Copper	Left	\$10,330.59
450199	TZH060CGD05CLSS	5	Straight	Yes	Copper	Left	\$10,435.07
450198	TZH060CGD05CRBS	5	Back	Yes	Copper	Right	\$10,435.07
450197	TZH060CGD05CRSS	5	Straight	Yes	Copper	Right	\$10,330.59

Auxiliary Heaters for Horizontal Installation, Modulating Valve for Closed Loop

HVAC No.	MFG Part No.	Description	Size	Price
361741	AGL10AAG	Fits TZH048, TZH060	10 KW	\$467.38
361749	AGM12AAG	Fits TZH030, TZH036, TZH042	12 KW	\$635.90
361751	AGL15AAG	Fits TZH048, TZH060	15 KW	\$740.40
361752	AGL20AAG	Fits TZH048, TZH060	20 KW	\$806.67

GEOHERMAL EQUIPMENT

GEOTHERMAL EQUIPMENT

ClimateMaster-Residential

Tranquility 30 Indoor Split

Modulating Valve for Open Loop



- 25.6 EER/4.3 COP
- Most efficient ENERGY STAR® designation
- iGate™ communicating system
- Cupro-nickel water coil
- Internal, variable water flow control valve included
- Optional built-in hot water generator
- Standard 10 year limited warranty on all parts with 5 year labor allowance
- Optional extended 5 year limited labor allowance available for a total of 10 year labor allowance
- Made in the USA

HVAC No.	MFG Part No.	Tons A/C	Hot H2O Gen	Indoor Coil	Price
423152	TES026BGD06JNNS	2	No	Cupro-Nickel	\$6,883.70
423153	TES026BGD06NNNS	2	Yes	Cupro-Nickel	\$7,666.13
423157	TES038BGD06JNNS	3	No	Cupro-Nickel	\$7,845.41
423158	TES038BGD06NNNS	3	Yes	Cupro-Nickel	\$8,661.07
423163	TES049BGD06JNNS	4	No	Cupro-Nickel	\$8,803.75
423164	TES049BGD06NNNS	4	Yes	Cupro-Nickel	\$9,620.54
423169	TES064BGD06JNNS	5	No	Cupro-Nickel	\$9,553.13
423170	TES064BGD06NNNS	5	Yes	Cupro-Nickel	\$10,365.41

Internal Controller or Modulating Valve for Closed Loop



- 25.6 EER/4.3 COP
- Most efficient ENERGY STAR® designation
- iGate™ communicating system
- Copper water coil
- Internal, variable speed water flow control (vFlow™) included
- Optional built-in hot water generator
- Standard 10 year limited warranty on all parts with 5 year labor allowance
- Optional extended 5 year limited labor allowance available for a total of 10 year labor allowance
- Made in the USA

HVAC No.	MFG Part No.	Tons A/C	Hot H2O Gen	Indoor Coil	Water Circuit	Price
423148	TES026BGD02ANNS	2	No	Copper	Internal Pump	\$8,072.36
423149	TES026BGD02CNNS	2	Yes	Copper	Internal Pump	\$8,888.02
423150	TES026BGD05ANNS	2	No	Copper	Valve Closed Loop	\$6,408.44
423151	TES026BGD05CJNS	2	Yes	Copper	Valve Closed Loop	\$7,225.24
423143	TES038BGD02ANNS	3	No	Copper	Internal Pump	\$9,039.68
423154	TES038BGD02CNNS	3	Yes	Copper	Internal Pump	\$9,855.34
423155	TES038BGD05ANNS	3	No	Copper	Valve Closed Loop	\$7,370.16
423156	TES038BGD05CNNS	3	Yes	Copper	Valve Closed Loop	\$8,185.82
423159	TES049BGD02ANNS	4	No	Copper	Internal Pump	\$9,900.28
423160	TES049BGD02CNNS	4	Yes	Copper	Internal Pump	\$10,715.94
423161	TES049BGD05ANNS	4	No	Copper	Valve Closed Loop	\$8,102.68
423162	TES049BGD05CNNS	4	Yes	Copper	Valve Closed Loop	\$8,918.34
423165	TES064BGD02ANNS	5	No	Copper	Internal Pump	\$10,449.68
423166	TES064BGD02CNNS	5	Yes	Copper	Internal Pump	\$11,265.35
423167	TES064BGD05ANNS	5	No	Copper	Valve Closed Loop	\$8,797.01
423168	TES064BGD05CNNS	5	Yes	Copper	Valve Closed Loop	\$9,614.91

GEOTHERMAL EQUIPMENT

ClimateMaster-Residential

Tranquility 30 Outdoor Split

High Head Internal Controller for Closed Loop



- 25.6 EER/4.3 COP
- Most efficient ENERGY STAR® designation
- iGate™ communicating system
- Copper water coil
- Internal, variable speed water flow control (vFlow™) included
- Optional built-in hot water generator
- Standard 10 year limited warranty on all parts with 5 year labor allowance
- Optional extended 5 year limited labor allowance available for a total of 10 year labor allowance
- Made in the USA

HVAC No.	MFG Part No.	Tons A/C	Hot H2O Gen	Indoor Coil	Water Circuit	Price
423145	TEP026BGD02ANNS	2	No	Copper	Internal Pump	\$8,712.75
423144	TEP038BGD02ANNS	3	No	Copper	Internal Pump	\$9,061.04
423146	TEP049BGD02ANNS	4	No	Copper	Internal Pump	\$10,900.20
423147	TEP064BGD02ANNS	5	No	Copper	Internal Pump	\$11,059.73

Convertible Cased Coil

Split System Indoor Coil



- Has the highest efficiency ratings of any geothermal split system in the industry when matched with a ClimateMaster Tranquility indoor or outdoor unit
- Is multi-positional, available in vertical upflow or downflow and horizontal left or right airflow
- Designed for retrofit applications, including adding geothermal as a dual fuel option
- Standard 10 year limited warranty on all parts with 5 year labor allowance
- Optional extended 5-year limited labor allowance available for a total of 10 year labor allowance
- Made in the USA

HVAC No.	MFG Part No.	Tons A/C	Coil Width	Coil Height x Depth	Configuration	Price
392124	TAC026AM21S	2	21"	20" x 17.5"	Upflow, Downflow, Horizontal	\$1,052.73
392123	TAC026AM17S	2	17"	20" x 17.9"	Upflow, Downflow, Horizontal	\$966.21
392125	TAC038AM21S	3	21"	28" x 17.5"	Upflow, Downflow, Horizontal	\$1,102.16
392126	TAC038AM24S	3	24"	32" x 30.3"	Upflow, Downflow, Horizontal	\$1,504.38
392127	TAC049AM21S	4	21"	28" x 25.9"	Upflow, Downflow, Horizontal	\$1,386.40
392128	TAC049AM24S	4	24"	32" x 30.3"	Upflow, Downflow, Horizontal	\$1,504.38
451329	TAC064BM24S	5	24"	32" x 30.3"	Upflow, Downflow, Horizontal	\$2,082.97

Tranquility 27 Split System

Air Handler



- Ideal for new installations or add-on air conditioning
- Designed for use with iGate™™ communicating control, which simplifies set-up and troubleshooting
- Unique drain pan design maximizes application flexibility and condensate removal
- Features 2 sets of ¾" FPT condensate drain connections for ease of connection
- Standard 10 year limited warranty on all parts with 5-year labor allowance
- Optional extended 5 year limited labor allowance available for a total of 10 year labor allowance
- Made in the USA

HVAC No.	MFG Part No.	Tons A/C	Cabinet Width	Voltage	Price
392115	TAH026AGSMAS	2	18-1/2"	208-230/60/1	\$4,012.03
392116	TAH026AGSMBS	2	22-1/2"	208-230/60/1	\$4,292.90
392118	TAH038AGSMBS	3	22-1/2"	208-230/60/1	\$4,545.68
392119	TAH038AGSMCS	3	25-1/2"	208-230/60/1	\$4,782.75
392120	TAH049AGSMBS	4	22-1/2"	208-230/60/1	\$4,805.22
392121	TAH049AGSMCS	4	25-1/2"	208-230/60/1	\$5,023.18
392122	TAH064AGSMCS	5	25-1/2"	208-230/60/1	\$5,378.21

Auxiliary Heaters

HVAC No.	MFG Part No.	Description	Size	Price
411125	AGM04CAG	Fits TAH026	4KW	\$397.72

GEOTHERMAL EQUIPMENT

ClimateMaster-Residential

Tranquility 27 Split System

Auxiliary Heaters

HVAC No.	MFG Part No.	Description	Size	Price
411126	AGM05CAG	Fits TAH026	5KW	\$396.61
393156	AGM08CAG	Fits TAH026	8KW	\$447.15
411127	AGM10CAG	Fits TAH026	10KW	\$465.13
393157	AGL10CAG	Fits TAH038, TAH049, TAH064	10KW	\$476.36
393158	AGL15CAG	Fits TAH038, TAH049, TAH064	15KW	\$689.83
393161	AGL20CAG	Fits TAH049, TAH064	20KW	\$759.49

Packaged Unit Accessories

Blower Motor Upgrade Kit for Tranquility 20, from PSC to ECM2

HVAC No.	MFG Part No.	Description	Includes:	Price
361758	EUKTS018	Fits TSV018, TSH018, TSD018	Motor, Blower Housing and Motor Belly Band	\$1,177.43
361759	EUKTS024	Fits TSV024, TSH024, TSD024	Motor and Motor Belly Band	\$1,078.56
361760	EUKTS030	Fits TSV030, TSH030, TSD030	Motor and Motor Belly Band	\$1,078.56

Auxiliary Heaters

HVAC No.	MFG Part No.	Size	Price
361735	AGM05AAG	5 KW	\$377.50
361739	AGM10AAG	10 KW	\$447.15
361741	AGL10AAG	10 KW	\$467.38
361749	AGM12AAG	12 KW	\$635.90
361751	AGL15AAG	15 KW	\$740.40
361752	AGL20AAG	20 KW	\$806.67
411125	AGM04CAG	4 KW	\$397.72
411126	AGM05CAG	5 KW	\$396.61
393156	AGM08CAG	8 KW	\$447.15
393156	AGM08CAG	8 KW	\$447.15
411127	AGM10CAG	10 KW	\$465.13
393157	AGL10CAG	10 KW	\$476.36
393158	AGL15CAG	15 KW	\$689.83
393161	AGL20CAG	20 KW	\$759.49

Misc. Items

HVAC No.	MFG Part No.	Description	Price
361679	ATS007	Control Checker	\$71.90
418378	ACDU02	DXM 2 Diagnostic Tool	\$552.76
361686	S17S0018N01	Potentiometer	\$115.77
361765	ASPK	Residential Service Parts Kit	\$1,210.02

Replacement Air Filters

HVAC No.	MFG Part No.	Description	Size	Notes	Price
99731	P411420	Fits TZH036/042	14" x 20" x 1"	2 per unit	\$9.01
99740	P411824	Fits TZH024/030	18" x 24" x 1"	1 per unit	\$12.26
99742	P412020	Fits TZV024/030	20" x 20" x 1"	1 per unit	\$8.69
99748	P412424	Fits TZV036/042	24" x 24" x 1"	1 per unit	\$12.03
99848	P622024	Fits TEH064/072, TSH060/070	20" x 24" x 2"	2 per unit	\$17.22
99850	P622424	Fits TSV018, TSD018	24" x 24" x 2"	1 per unit	\$24.78
322414	P4C1D-600-799	Fits TZV048/060	28" x 28" x 1"	1 per unit	\$39.59
370338	P6C2D-600-699	Fits TEV026, TED026, TSV024/030, TSD024/030	24" x 28" x 2"	1 per unit	\$34.04
370340	P6C2D-800-999	Fits TEV038, TED038, TSV036, TSD036	28" x 30" x 2"	1 per unit	\$52.69
370382	P6C2D-800-999	Fits TEV049, TED049, TSV042/048, TSD042/048	30" x 32" x 2"	1 per unit	\$52.69
370383	P6C2D-1000-1199	Fits TEV064/072, TED064/072, TSV060/070, TSD060/070	30" x 36" x 2"	1 per unit	\$50.80
370384	P6C2-300-399	Fits TSH018/024/030	18" x 18" x 2"	2 per unit	\$19.66
370384	P6C2-300-399	Fits TSH018/024/030	18" x 18" x 2"	2 per unit	\$19.66

GEOTHERMAL EQUIPMENT

ClimateMaster-Residential

Packaged Unit Accessories

Replacement Air Filters

HVAC No.	MFG Part No.	Description	Size	Notes	Price
370386	P6C2-300-399	Fits TEH049, TSH042/048	18" x 20" x 2"	1 plus 1 99848	\$17.24
99743	P412024	Fits TZH048/060	20" x 24" x 1"	1 plus 1 99731	\$11.82
99837	P621220	Fits TEH038, TSH036	12" x 20" x 2"	1 plus 1 99849	\$11.91
99849	P622025	Fits TEH038, TSH036	20" x 25" x 2"	1 plus 1 99837	\$17.33

Thermostats

HVAC No.	MFG Part No.	Description	Price
365730	ATA21U01	ACO or MCO Digital	\$113.48
380050	ATP32U03	ACO Programmable Digital	\$446.40
380052	ATP32U04	ACO Programmable Digital	\$557.38
418377	ATC32U02	ACO Programmable Digital	\$469.35
410938	ATC32U01C	ACO Programmable Digital	\$402.21

Closed Loop Accessories

Double O-Ring Adaptor Fittings

HVAC No.	MFG Part No.	Description	Notes	Price
361665	AFC6F	1-1/4" PE Socket Fusion	Set of Two	\$34.84
361666	AFC5F	1" PE Socket Fusion	Set of Two	\$34.84
364756	AFC6I	1-1/4" Brass Barb Insert	Set of Two	\$140.45
361696	AFC4I	1" Brass Barb Insert	Set of Two	\$137.07
361676	AFC4C	1" Cam Lever - For Flush Connections	Set of Two	\$46.07
361703	AFC4T	1" MPT Brass thread	Set of Two	\$156.18

Hose Kits and Pieces

HVAC No.	MFG Part No.	Description	Price
417874	AHK5PE	Vflow Hose Kit, 10'	\$403.79
361728	AHK5EC	10ft of 1 Inch Hose & Fittings For Each End	\$292.11
361687	ARH510	10' of 1" Hose	\$139.31
361731	ARH550	50' of 1" Hose	\$665.70

Flow Controllers



HVAC No.	MFG Part No.	Description	Includes:	Price
361766	AFCG1C1	Flow Controller, 3-Way, Composite	1 Grundfos UP26-99	\$1,210.02
361775	AFCG2C1	Flow Controller, 3-Way, Composite	2 Grundfos UP26-99	\$1,640.31
361774	AFCG1B1	Flow Controller, 3-Way, Brass	1 Grundfos UP26-99	\$1,558.31
361776	AFCG2B1	Flow Controller, 3-Way, Brass	2 Grundfos UP26-99	\$2,054.89
361777	AFCG2B2	Flow Controller, 3-Way, Brass	2 Grundfos UP26-116	\$2,054.89
361695	APSM	Accessory Pump Slaving Module	Lets 2 Units Control a Single Flow Controller	\$106.74

Chamberlin Hose Kits



HVAC No.	MFG Part No.	Description	Price
394731	CR3ACY-050-24-3GPM	Hose Kit #3, 1/2" x 24", 3 gpm	\$442.28
447266	CR3ACY-050-24-4GPM	Hose Kit #3, 1/2" x 24", 4 gpm	\$423.19
447262	CR3ACY-075-24-6GPM	Hose Kit #3, 3/4" x 24", 6 gpm	\$496.67
447263	CR3ACY-075-24-7.5GPM	Hose Kit #3, 3/4" x 24", 7.5 gpm	\$475.23
394730	CR3ACY-075-24-8GPM	Hose Kit #3, 3/4" x 24", 8 gpm	\$550.47
447265	CR3ACY-075-24-9GPM	Hose Kit #3, 3/4" x 24", 9 gpm	\$475.23
447261	CR3ACY-100-24-12GPM	Hose Kit #3, 1" x 24", 12 gpm	\$664.34
394732	CR3ACY-100-24-15GPM	Hose Kit #3, 1" x 24", 15 gpm	\$666.10
389409	CR3ACY-200-36-45150	Hose Kit #3, 2" x 36", 45 - 150 gpm	\$1,692.89
447259	HVAC-SS-1X24	Single Hose Assembly, 1" x 24"	\$139.63
446197	HVAC-SS-3/4X24	Single Hose Assembly, 3/4" x 24"	\$76.17

GEOTHERMAL EQUIPMENT

ClimateMaster-Residential

Open Loop Accessories

Port Fittings

HVAC No.	MFG Part No.	Description	Notes	Price
361663	70022002	Pressure/Temperature Plug	Brass 1/4" MPT	\$22.47
361664	70022003	Pressure/Temperature Plug	Brass 1/2" MPT	\$26.96
323412	BP25-NP	Pressure/Temperature Plug	Petes Plug	\$7.31
361667	APTGA	Gauge Probe Port Adaptor	Use on P/T Plugs	\$71.90

Misc. Items

HVAC No.	MFG Part No.	Description	Size	Price
361734	AVMB5	Brass Motorized Valve, With End Switch Safety Controls, 24 VAC	1" Sweat	\$374.14
361707	AVMB-PH	Replacement Power Head for AVMB5		\$177.51
364518	AFRV-CUSTOM	Brass Flow Regulator, 2 - 10 GPM	3/4" x 3/4" FPT	\$123.59

GEOTHERMAL EQUIPMENT

GEOTHERMAL EQUIPMENT

ClimateMaster Nomenclature

ClimateMaster Nomenclature

1 2 3 4 5 6 7 8 9 10 11 12 13 14 15

TE **V** **026** **A** **G** **D** **0** **2** **C** **L** **T** **S**

SERIES
TE = Tranquility® 30 Digital

CONFIGURATION
V = Vertical Up
H = Horizontal
D = Down Flow

UNIT SIZE
026
036
049
064
072

REVISION LEVEL
B = Current Revision

VOLTAGE
G = 208/230/60/1 Ⓞ

CONTROLS
D = DXM2
B = DXM2 w/Disconnect
4 = DXM2 w/SecureStart

CABINET
0 = Residential

STANDARD
S = Standard

SUPPLY AIR FLOW & MOTOR CONFIGURATION

	Supply	Configuration
T	Top	TEV
B	Back	TEH
S	Straight	TEH
D	Down	TEH

RETURN AIR FLOW CONFIGURATION
L = Left Return w/ 2" Merv 11 pleated filter and frame
R = Right Return w/ 2" Merv 11 pleated filter and frame

HEAT EXCHANGER OPTIONS

	Copper	Cupro-Nickel
HWG W/Pump (Standard)	C	N
No HWG	A	J

WATER CIRCUIT OPTIONS
0 = None
1 = Internal Flow Controller Standard Head - Closed Loop (available for unit sizes 026 and 036 only)
2 = Internal Flow Controller High Head - Closed Loop
5 = Motorized Modulating Valve (Central Pumping Applications) - Closed Loop
Ⓞ = Motorized Modulating Valve (Ground Water Applications) - Open Loop

In Position 11 and 12, only the following combinations are available:

With HWG	Without HWG	Description
1C	1A	Internal Flow Controller Standard Head with Copper Water Coil
2C	2A	Internal Flow Controller High Head with Copper Water Coil
5C	5A	Motorized Modulating Valve with Copper Water Coil
ⓄN	ⓄJ	Motorized Modulating Valve with Cupro-Nickel Water Coil
0C	0A	No vFlow with Copper Water Coil
0N	0J	No vFlow with Cupro-Nickel Water Coil

1 2 3 4 5 6 7 8 9 10 11 12 13 14 15

TZ **V** **024** **B** **G** **D** **0** **2** **C** **L** **T** **S**

SERIES
TZ = Tranquility® 22 Digital

CONFIGURATION
V = Vertical Up
H = Horizontal

UNIT SIZE
024, 030, 036, 042, 048, 060

REVISION LEVEL
C = Current Revision

VOLTAGE
G = 208-230/60/1

CONTROLS
D = DXM2

CABINET
0 = Residential

STANDARD
S = Standard

SUPPLY AIR FLOW & MOTOR CONFIGURATION

	Supply	Configuration	Motor
T	Top	TZV	ECM
B	Back	TZH	ECM
S	Straight	TZH	ECM

RETURN AIR FLOW CONFIGURATION
L = Left Return w/ 1" Merv 8 pleated filter and frame
R = Right Return w/ 1" Merv 8 pleated filter and frame

HEAT EXCHANGER OPTIONS

	Tin Plated Air Coil	Copper	Cupro-Nickel
HWG W/Pump (Standard)	C	N	
No HWG	A	J	

WATER CIRCUIT OPTIONS
0 = None
1 = Internal Flow Controller Standard Head - Closed Loop (available for unit sizes 024 to 036 only)
2 = Internal Flow Controller High Head - Closed Loop
5 = Motorized Modulating Valve (Central Pumping Applications) - Closed Loop
Ⓞ = Motorized Modulating Valve (Ground Water Applications) - Open Loop

In Position 11 and 12, only the following combinations are available:

With HWG	Without HWG	Description
1C	1A	Internal Flow Controller Standard Head with Copper Water Coil
2C	2A	Internal Flow Controller High Head with Copper Water Coil
5C	5A	Motorized Modulating Valve with Copper Water Coil
6N	6J	Motorized Modulating Valve with Cupro-Nickel Water Coil
0C	0A	No vFlow with Copper Water Coil
0N	0J	No vFlow with Cupro-Nickel Water Coil

GEOTHERMAL EQUIPMENT

ClimateMaster Nomenclature

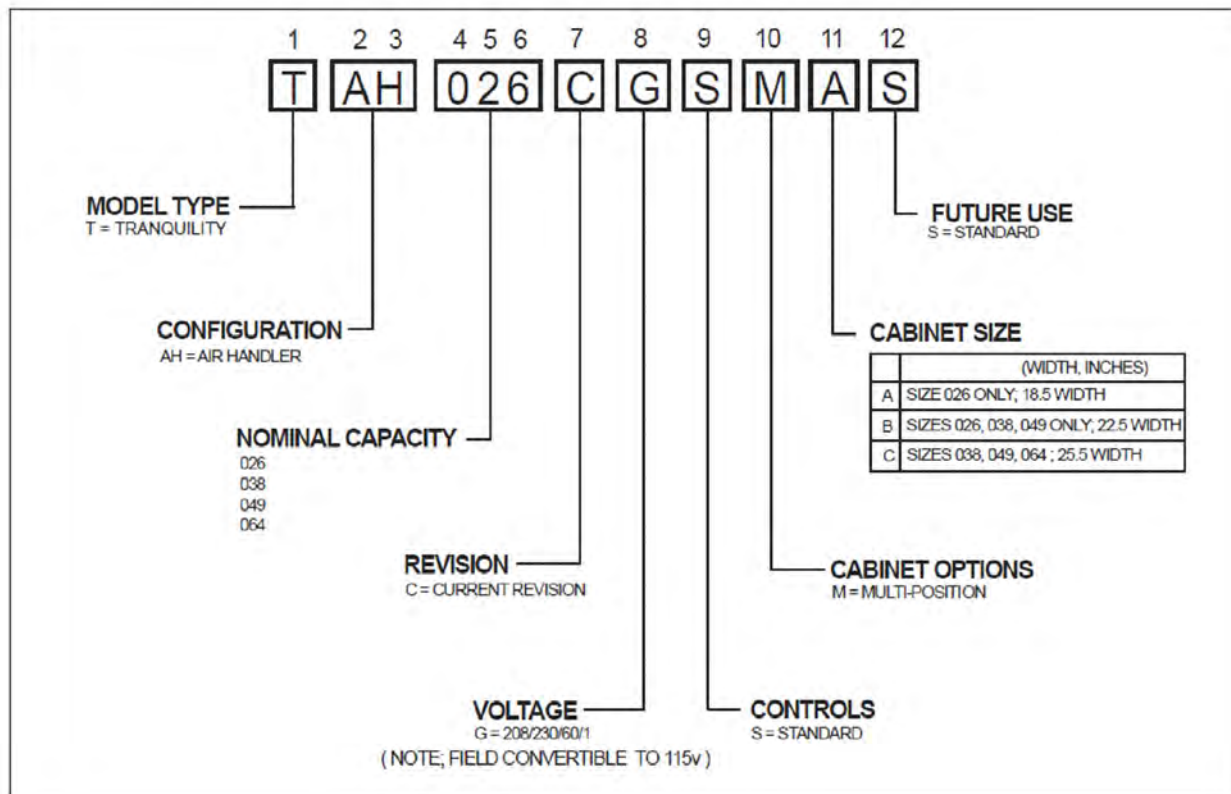
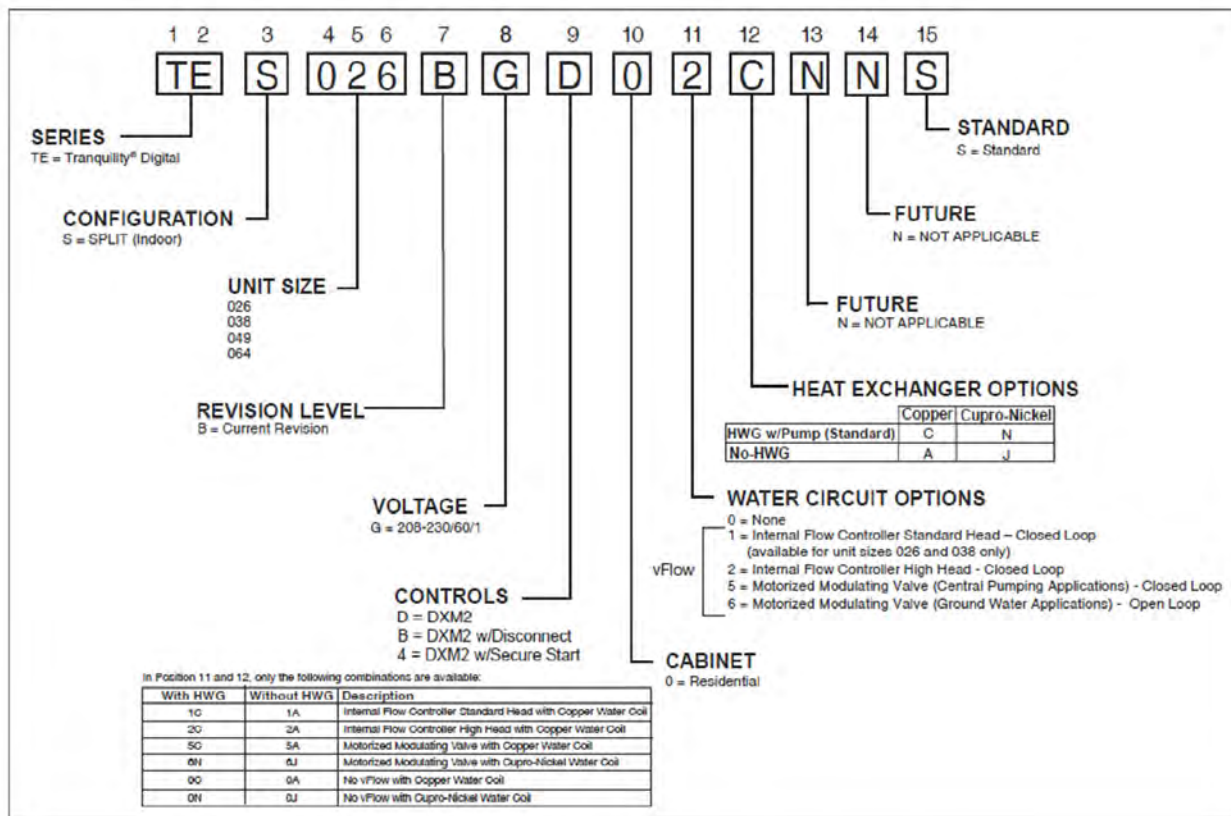

GEOTHERMAL EQUIPMENT

GEOTHERMAL EQUIPMENT

ClimateMaster Nomenclature

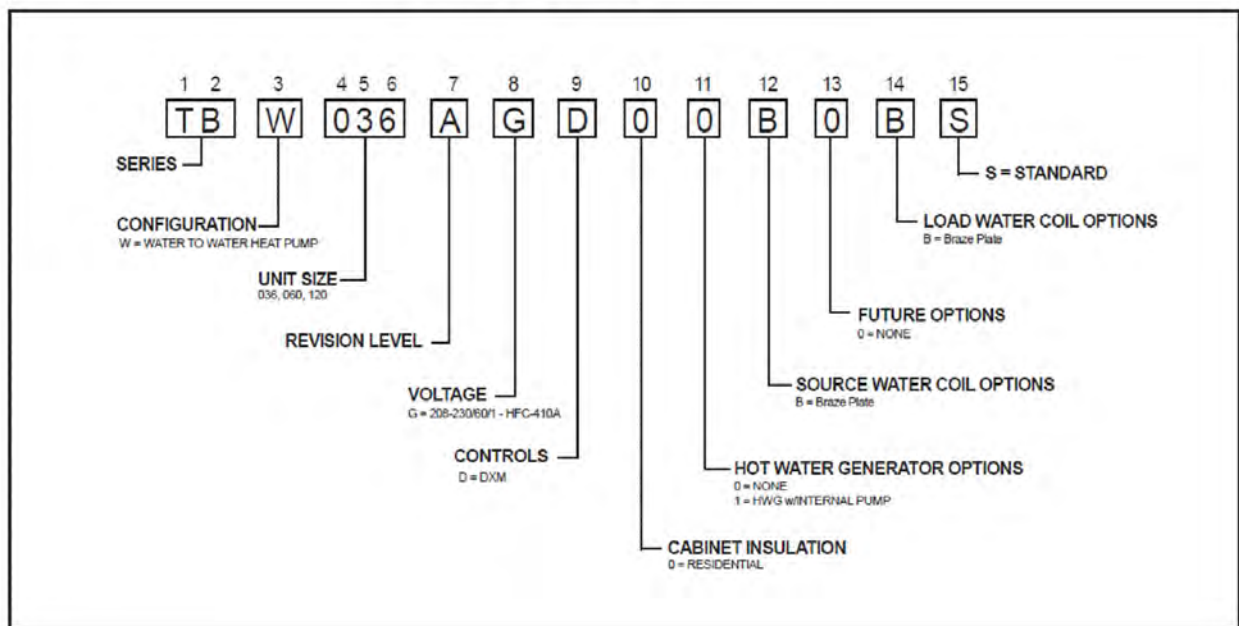
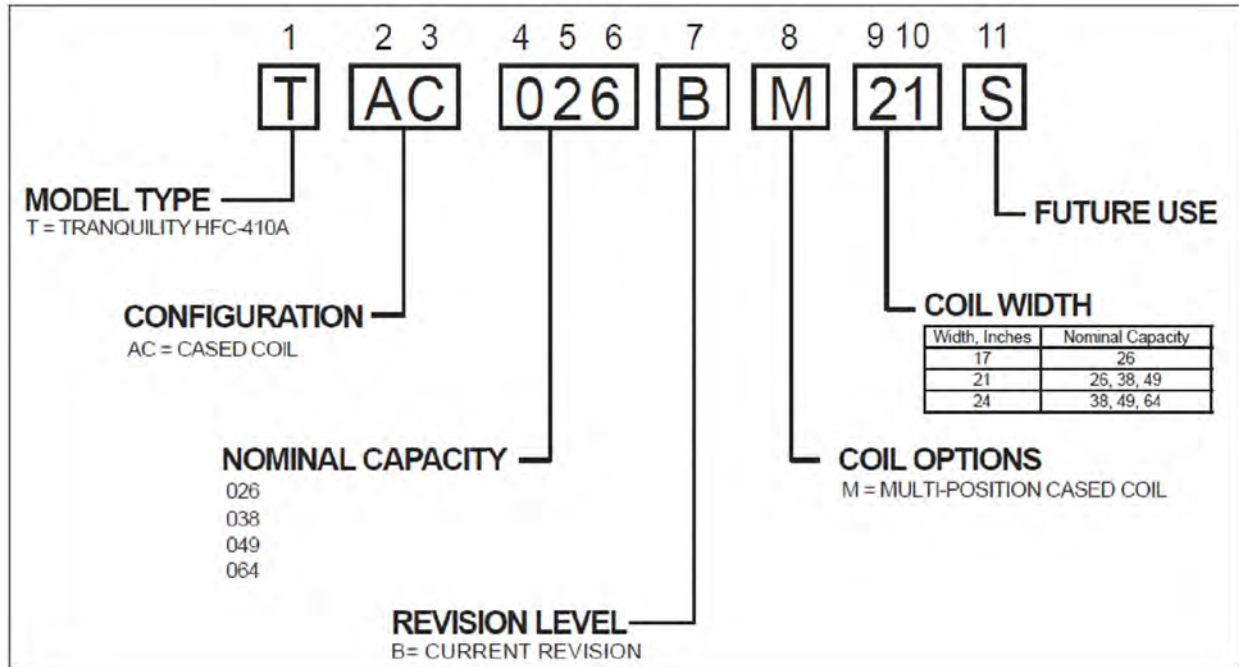

GEOTHERMAL EQUIPMENT

GEOTHERMAL EQUIPMENT

ClimateMaster Nomenclature

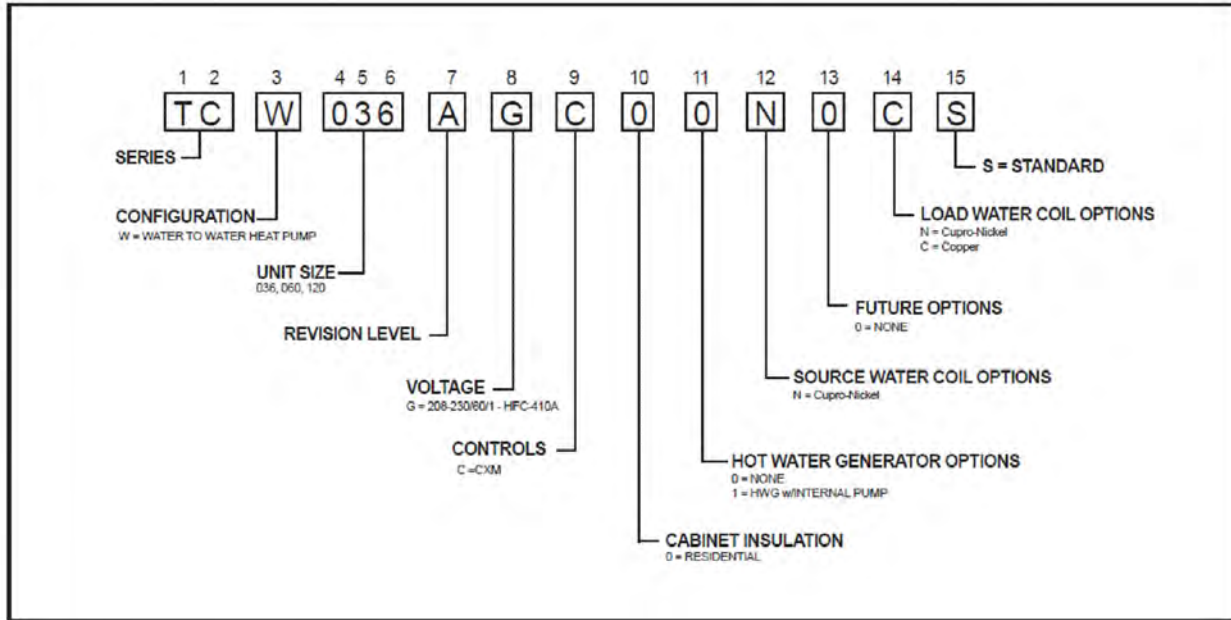

GEOTHERMAL EQUIPMENT

GEOTHERMAL EQUIPMENT

ClimateMaster Water-to-Air Start Up and Troubleshooting Form



Packaged Water-to-Air Troubleshooting Form

RP929

Customer: _____ Loop Type: _____ Startup Date: _____

Model #: _____ Serial #: _____ Antifreeze Type & %: _____

Complaint: _____

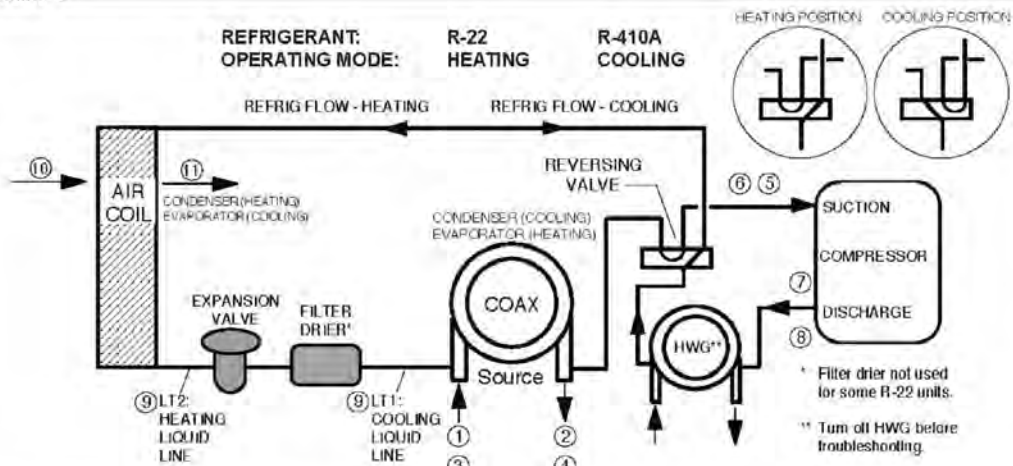

Description	Heating	Cooling	Notes
Water Side Analysis			
1 Water In Temp.			
2 Water Out Temp.			Temp. Diff. =
3 Water In Pressure			
4 Water Out Pressure			
4a Pressure Drop			
4b GPM			
Heat of Extraction (Absorption) or Heat of Rejection: HE or HR (Btuh) = _____ Enter HE or HR: _____			Fluid Factor: 500 (Water); 485 (Antifreeze)
_____ Flow Rate (GPM) x _____ Temp. Diff (deg F) x _____ Fluid Factor			
Refrigerant Analysis			
5 Suction Temp.			
6 Suction Pressure			
6a Saturation Temp.			
6b Superheat			
7 Discharge Temp.			
8 Discharge Pressure			
8a Saturation Temp.			
8b Subcooling			
9 Liquid Line Temp.			
10 Return Air Temp.			
11 Supply Air Temp.			Temp. Diff. =
Voltage			
Compress Amps			

Note: Never connect refrigerant gauges during startup procedures. Conduct water-side analysis using P/T ports to determine water flow and temperature difference. If water-side analysis shows poor performance, refrigerant troubleshooting may be required. Connect refrigerant gauges as a last resort.

GEOTHERMAL EQUIPMENT

GEOTHERMAL EQUIPMENT

ClimateMaster Water-to-Water Start Up and Troubleshooting Form



Refrigeration Troubleshooting Form Water-to-Air or Water-to-Water Units

Rev
081124

Customer: _____ Loop Type: _____ Startup Date: _____

Model #: _____ Serial #: _____ Antifreeze Type & %: _____

Complaint: _____

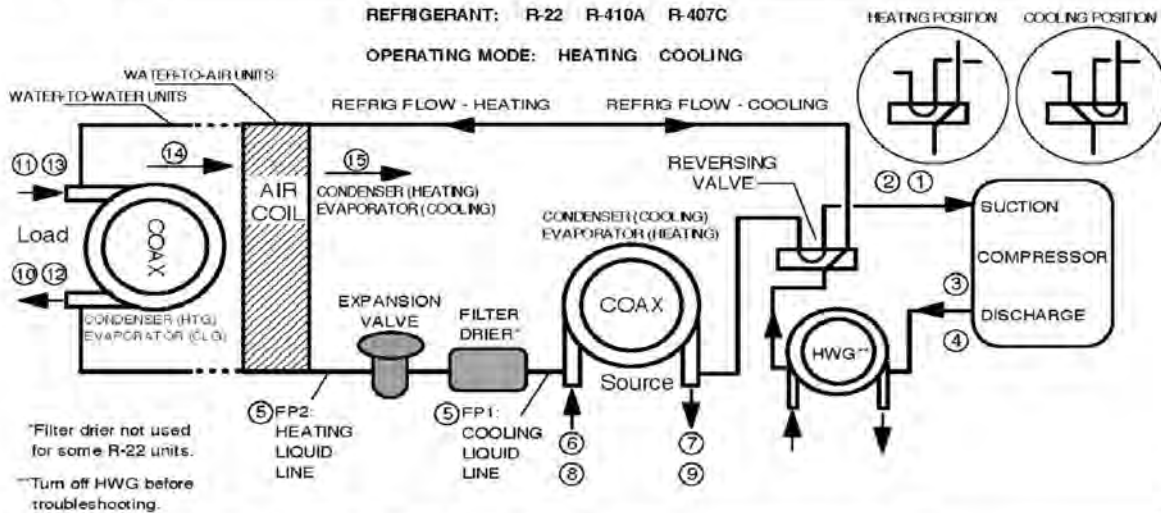

Description	Heating	Cooling	Notes
Voltage			
Compress Amps			
1 Suction Temp			
2 Suction Press			
2a Saturation Temp			
2b Superheat			
3 Discharge Temp			
4 Discharge Press			
4a Saturation Temp			
4b Subcooling			
5 Liquid Line Temp			
6 Source Water In Temp			
7 Source Water Out Temp			Temp Diff. =
8 Source Water In Pres			
9 Source Water Out Pres			
9a Press Drop			
9b GPM			
10 Load Water In Temp			<- Water-to-Water units only
11 Load Water Out Temp			Temp Diff. =
12 Load Water In Pres			<- Water-to-Water units only
13 Load Water Out Pres			<- Water-to-Water units only
13a Press Drop			<- Water-to-Water units only
13b GPM			<- Water-to-Water units only
14 Return Air Temp			<- Water-to-Air units only
15 Supply Air Temp			Temp Diff. =

Heat of Extraction (Absorption) or Heat of Rejection:

HE or HR (Btuh) = _____ Enter HE or HR: _____

Fluid Factor:
500 (Water); 485 (Antifreeze)

_____ Flow Rate (GPM) x _____ Temp. Diff (deg F) x _____ Fluid Factor

GEOTHERMAL EQUIPMENT

GEOTHERMAL EQUIPMENT

Calculating Heat of Rejection and Extraction

Verifying Performance of a Geothermal System Using Heat of Rejection and Heat of Extraction

Unit performance may be verified by calculating the unit heat of rejection and heat of extraction.

Heat of Rejection.

Heat of Rejection (HR) can be calculated and compared to the manufacturer's performance ratings when the unit is operating in cooling mode.

- The formula for HR is as follows: $HR = TD \times GPM \times 500$ (or 485 for anti-freeze solutions), where:
 - o TD is the temperature difference between the entering and leaving water,
 - o GPM is the flow rate in U.S. gallons per minute.

Heat of Extraction.

Heat of Extraction (HE) can be calculated and compared to the manufacturer's performance ratings when the unit is in heating mode.

- The formula for HE is as follows: $HE = TD \times GPM \times 500$ (or 485 for antifreeze solutions), where:
 - o TD is the temperature difference between the entering and leaving water,
 - o GPM is the flow rate in U.S. gallons per minute.